

LOW-NOISE, HIGH-SPEED, 450 mA CURRENT FEEDBACK AMPLIFIERS

FEATURES

- **Low Noise**
 - 2.9 pA/√Hz Noninverting Current Noise
 - 10.8 pA/√Hz Inverting Current Noise
 - 2.2 nV/√Hz Voltage Noise
- **High Output Current, 450 mA**
- **High Speed**
 - 128 MHz, –3 dB BW($R_L = 50 \Omega$, $R_F = 470 \Omega$)
 - 1550 V/ μ s Slew Rate ($G = 2$, $R_L = 50 \Omega$)
- **Wide Output Swing**
 - 26 V_{PP} Output Voltage, $R_L = 50 \Omega$
- **Low Distortion**
 - –80 dBc (1 MHz, 2 V_{PP}, $G = 2$)
- **Low Power Shutdown Mode (THS3125)**
 - 370- μ A Shutdown Supply Current
- **Standard SOIC, SOIC PowerPAD™, and TSSOP PowerPAD Package**

- **Line Drivers**
- **Motor Drivers**
- **Piezo Drivers**

DESCRIPTION

The THS3122/5 are low-noise, high-speed current feedback amplifiers, with high output current drive. This makes them ideal for any application that requires low distortion over a wide frequency with heavy loads. The THS3122/5 can drive four serially terminated video lines while maintaining a differential gain error less than 0.03%.

The high output drive capability of the THS3122/5 enables the devices to drive 50- Ω loads with low distortion over a wide range of output voltages:

- 80 –dBc THD at 2 V_{PP}
- 75 –dBc THD at 8 V_{PP}

The THS3122/5 can operate from ± 5 V to ± 15 V supply voltages while drawing as little as 7.2 mA of supply current per channel. They offer a low power shutdown mode, reducing the supply current to only 370 μ A. The THS3122/5 are packaged in a standard SOIC, SOIC PowerPAD™, and TSSOP PowerPAD packages.

APPLICATIONS

- **Video Distribution**
- **Instrumentation**

VOLTAGE NOISE AND CURRENT NOISE

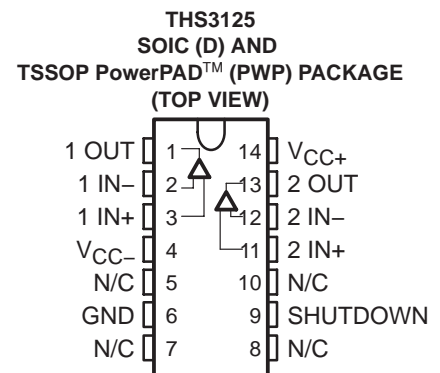
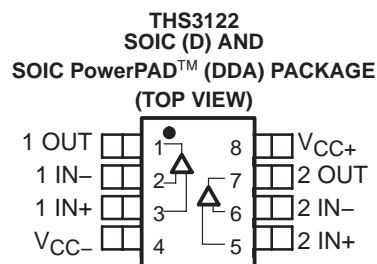
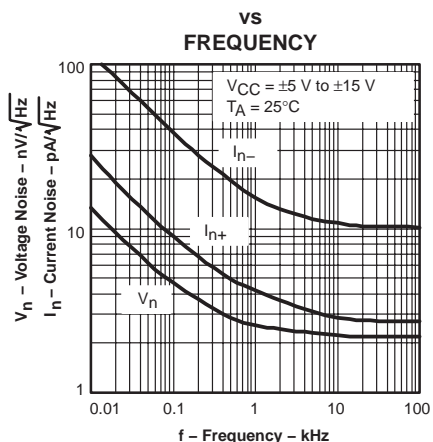

Please be aware that an important notice concerning availability, standard warranty, and use in critical applications of Texas Instruments semiconductor products and disclaimers thereto appears at the end of this data sheet.

PowerPAD is a trademark of Texas Instruments.

PRODUCTION DATA information is current as of publication date. Products conform to specifications per the terms of Texas Instruments standard warranty. Production processing does not necessarily include testing of all parameters.

AVAILABLE OPTIONS

T _A	PACKAGED DEVICE				EVALUATION MODULES
	SOIC-8 (D)	SOIC-8 PowerPAD (DDA)	SOIC-14 (D)	TSSOP-14 (PWP)	
0°C to 70°C	THS3122CD	THS3122CDDA	THS3125CD	THS3125CPWP	THS3122EVM
-40°C to 85°C	THS3122ID	THS3122IDDA	THS3125ID	THS3125IPWP	THS3125EVM

absolute maximum ratings over operating free-air temperature (unless otherwise noted)†

Supply voltage, V _{CC+} to V _{CC-}	33 V
Input voltage	± V _{CC}
Output current (see Note 1)	275 mA
Differential input voltage	± 4 V
Maximum junction temperature	150°C
Total power dissipation at (or below) 25°C free-air temperature	See Dissipation Ratings Table
Operating free-air temperature, T _A : Commercial	0°C to 70°C
Industrial	-40°C to 85°C
Storage temperature, T _{stg} : Commercial	-65°C to 125°C
Industrial	-65°C to 125°C
Lead temperature 1,6 mm (1/16 inch) from case for 10 seconds	300°C

† Stresses beyond those listed under “absolute maximum ratings” may cause permanent damage to the device. These are stress ratings only, and functional operation of the device at these or any other conditions beyond those indicated under “recommended operating conditions” is not implied. Exposure to absolute-maximum-rated conditions for extended periods may affect device reliability.

NOTE 1: The THS3122 and THS3125 may incorporate a PowerPAD™ on the underside of the chip. This acts as a heatsink and must be connected to a thermally dissipating plane for proper power dissipation. Failure to do so may result in exceeding the maximum junction temperature which could permanently damage the device. See TI Technical Brief SLMA002 for more information about utilizing the PowerPAD™ thermally enhanced package.

DISSIPATION RATING TABLE

PACKAGE	θ _{JA}	T _A = 25°C POWER RATING
D-8	95°C/W‡	1.32 W
DDA	67°C/W	1.87 W
D-14	66.6°C/W‡	1.88 W
PWP	37.5°C/W	3.3 W

‡ This data was taken using the JEDEC proposed high-K test PCB. For the JEDEC low-K test PCB, the θ_{JA} is 168°C/W for the D-8 package and 122.3°C/W for the D-14 package.

recommended operating conditions

		MIN	NOM	MAX	UNIT
Supply voltage, V _{CC+} to V _{CC-}	Dual supply	±5		±15	V
	Single supply	10		30	
Operating free-air temperature, T _A	C-suffix	0		70	°C
	I-suffix	-40		85	
Shutdown pin input levels, relative to the GND pin	High level (device shutdown)	2			V
	Low level (device active)			0.8	

electrical characteristics over recommended operating free-air temperature range, $T_A = 25^\circ\text{C}$,
 $V_{CC} = \pm 15\text{ V}$, $R_F = 750\ \Omega$, $R_L = 100\ \Omega$ (unless otherwise noted)

dynamic performance

PARAMETER		TEST CONDITIONS			MIN	TYP	MAX	UNIT
BW	Small-signal bandwidth (-3 dB)	$R_L = 50\ \Omega$	$R_F = 50\ \Omega$, $G = 1$	$V_{CC} = \pm 5\text{ V}$		138	MHz	
				$V_{CC} = \pm 15\text{ V}$		160		
		$R_L = 50\ \Omega$	$R_F = 470\ \Omega$, $G = 2$	$V_{CC} = \pm 5\text{ V}$		126		
				$V_{CC} = \pm 15\text{ V}$		128		
	Bandwidth (0.1 dB)		$R_F = 470\ \Omega$, $G = 2$	$V_{CC} = \pm 5\text{ V}$		20		
				$V_{CC} = \pm 15\text{ V}$		30		
Full power bandwidth	$G = -1$		$V_{O(PP)} = 4\text{ V}$	$V_{CC} = \pm 5\text{ V}$		47	MHz	
			$V_{O(PP)} = 20\text{ V}$	$V_{CC} = \pm 15\text{ V}$		64		
SR	Slew rate (see Note 2), $G=8$	$G = 2$ $R_F = 680\ \Omega$	$V_O = 10\text{ V}_{PP}$	$V_{CC} = \pm 15\text{ V}$		1550	$\text{V}/\mu\text{s}$	
			$V_O = 5\text{ V}_{PP}$	$V_{CC} = \pm 5\text{ V}$		500		
				$V_{CC} = \pm 15\text{ V}$		1000		
t_s	Settling time to 0.1%	$G = -1$		$V_O = 2\text{ V}_{PP}$	$V_{CC} = \pm 5\text{ V}$		53	ns
				$V_O = 5\text{ V}_{PP}$	$V_{CC} = \pm 15\text{ V}$		64	

NOTE 2: Slew rate is defined from the 25% to the 75% output levels.

noise/distortion performance

PARAMETER		TEST CONDITIONS			MIN	TYP	MAX	UNIT
THD	Total harmonic distortion	$G = 2$, $R_F = 470\ \Omega$, $V_{CC} = \pm 15\text{ V}$, $f = 1\text{ MHz}$		$V_{O(PP)} = 2\text{ V}$		-80	dBc	
				$V_{O(PP)} = 8\text{ V}$		-75		
		$G = 2$, $R_F = 470\ \Omega$, $V_{CC} = \pm 5\text{ V}$, $f = 1\text{ MHz}$		$V_{O(PP)} = 2\text{ V}$		-77		
				$V_{O(PP)} = 5\text{ V}$		-76		
V_n	Input voltage noise	$V_{CC} = \pm 5\text{ V}, \pm 15\text{ V}$		$f = 10\text{ kHz}$		2.2	$\text{nV}/\sqrt{\text{Hz}}$	
I_n	Input current noise	Noninverting Input	$V_{CC} = \pm 5\text{ V}, \pm 15\text{ V}$		$f = 10\text{ kHz}$		2.9	$\text{pA}/\sqrt{\text{Hz}}$
		Inverting Input					10.8	
Crosstalk		$G = 2$, $f = 1\text{ MHz}$, $V_O = 2\text{ V}_{PP}$		$V_{CC} = \pm 5\text{ V}$		-67	dBc	
				$V_{CC} = \pm 15\text{ V}$		-67		
Differential gain error		$G = 2$, $R_L = 150\ \Omega$ 40 IRE modulation		$V_{CC} = \pm 5\text{ V}$		0.01%		
				$V_{CC} = \pm 15\text{ V}$		0.01%		
Differential phase error		$\pm 100\text{ IRE Ramp}$ NTSC and PAL		$V_{CC} = \pm 5\text{ V}$		0.011°		
				$V_{CC} = \pm 15\text{ V}$		0.011°		

electrical characteristics over recommended operating free-air temperature range, $T_A = 25^\circ\text{C}$, $V_{CC} = \pm 15\text{ V}$, $R_F = 750\ \Omega$, $R_L = 100\ \Omega$ (unless otherwise noted) (continued)

dc performance

PARAMETER		TEST CONDITIONS		MIN	TYP	MAX	UNIT
V_{IO}	Input offset voltage	$V_{IC} = 0\text{ V}$, $V_O = 0\text{ V}$, $V_{CC} = \pm 5\text{ V}$, $V_{CC} = \pm 15\text{ V}$	$T_A = 25^\circ\text{C}$	4.4	6	mV	
			$T_A = \text{full range}$		8		
	Channel offset voltage matching		$T_A = 25^\circ\text{C}$	0.4	2		
			$T_A = \text{full range}$		3		
Offset drift		$T_A = \text{full range}$	10		$\mu\text{V}/^\circ\text{C}$		
I_{IB}	IN– Input bias current	$V_{IC} = 0\text{ V}$, $V_O = 0\text{ V}$, $V_{CC} = \pm 5\text{ V}$, $V_{CC} = \pm 15\text{ V}$	$T_A = 25^\circ\text{C}$	6	23	μA	
			$T_A = \text{full range}$		30		
	IN+ Input bias current		$T_A = 25^\circ\text{C}$	0.33	2		
			$T_A = \text{full range}$		3		
I_{IO}	Input offset current	$V_{IC} = 0\text{ V}$, $V_O = 0\text{ V}$, $V_{CC} = \pm 5\text{ V}$, $V_{CC} = \pm 15\text{ V}$	$T_A = 25^\circ\text{C}$	5.4	22	μA	
			$T_A = \text{full range}$		30		
Z_{OL}	Open loop transimpedance	$V_{CC} = \pm 5\text{ V}$, $V_{CC} = \pm 15\text{ V}$	$R_L = 1\text{ k}\Omega$		1		M Ω

input characteristics

PARAMETER		TEST CONDITIONS		MIN	TYP	MAX	UNIT
V_{ICR}	Input common-mode voltage range	$V_{CC} = \pm 5\text{ V}$	$T_A = \text{full range}$	± 2.5	± 2.7	V	
		$V_{CC} = \pm 15\text{ V}$		± 12.5	± 12.7		
CMRR	Common-mode rejection ratio	$V_{CC} = \pm 5\text{ V}$, $V_I = -2.5\text{ V to } 2.5\text{ V}$	$T_A = 25^\circ\text{C}$	58	62	dB	
			$T_A = \text{full range}$	56			
		$V_{CC} = \pm 15\text{ V}$, $V_I = -12.5\text{ V to } 12.5\text{ V}$	$T_A = 25^\circ\text{C}$	63	67		
			$T_A = \text{full range}$	60			
R_I	Input resistance	IN+		1.5		M Ω	
		IN–		15		Ω	
C_i	Input capacitance			2		pF	

output characteristics

PARAMETER		TEST CONDITIONS		MIN	TYP	MAX	UNIT
V_O	Output voltage swing	$G = 4$, $V_I = 1.06\text{ V}$, $V_{CC} = \pm 5\text{ V}$	$R_L = 1\text{ k}\Omega$, $T_A = 25^\circ\text{C}$		4.1		V
		$G = 4$, $V_I = 1.025\text{ V}$, $V_{CC} = \pm 5\text{ V}$	$R_L = 50\ \Omega$	$T_A = 25^\circ\text{C}$	3.8	4	V
				$T_A = \text{full range}$	3.7		
		$G = 4$, $V_I = 3.6\text{ V}$, $V_{CC} = \pm 15\text{ V}$	$R_L = 1\text{ k}\Omega$, $T_A = 25^\circ\text{C}$		14.2		
		$G = 4$, $V_I = 3.325\text{ V}$, $V_{CC} = \pm 15\text{ V}$	$R_L = 50\ \Omega$	$T_A = 25^\circ\text{C}$	12	13.3	V
				$T_A = \text{full range}$	11.5		
I_O	Output current drive	$G = 4$, $V_I = 1.025\text{ V}$, $V_{CC} = \pm 5\text{ V}$	$R_L = 10\ \Omega$, $T_A = 25^\circ\text{C}$	200	280	mA	
		$G = 4$, $V_I = 3.325\text{ V}$, $V_{CC} = \pm 15\text{ V}$	$R_L = 25\ \Omega$, $T_A = 25^\circ\text{C}$	360	440	mA	
r_o	Output resistance		open loop $T_A = 25^\circ\text{C}$		14	Ω	

electrical characteristics over recommended operating free-air temperature range, $T_A = 25^\circ\text{C}$, $V_{CC} = \pm 15\text{ V}$, $R_F = 750\ \Omega$, $R_L = 100\ \Omega$ (unless otherwise noted) (continued)

power supply

PARAMETER		TEST CONDITIONS		MIN	TYP	MAX	UNIT
I_{CC}	Quiescent current (per channel)	$V_{CC} = \pm 5\text{ V}$	$T_A = 25^\circ\text{C}$	7.2	9	mA	
			$T_A = \text{full range}$	10			
		$V_{CC} = \pm 15\text{ V}$	$T_A = 25^\circ\text{C}$	8.4	10.5		
			$T_A = \text{full range}$	11.5			
PSRR	Power supply rejection ratio	$V_{CC} = \pm 5\text{ V} \pm 1\text{ V}$	$T_A = 25^\circ\text{C}$	53	60	dB	
			$T_A = \text{full range}$	50			
		$V_{CC} = \pm 15\text{ V} \pm 1\text{ V}$	$T_A = 25^\circ\text{C}$	68	73		
			$T_A = \text{full range}$	66			

shutdown characteristics (THS3125 only)

PARAMETER		TEST CONDITIONS		MIN	TYP	MAX	UNIT
$I_{CC}(\text{SHDN})$	Shutdown quiescent current (per channel)	$GND = 0\text{ V}$ $V_{CC} = \pm 5\text{ V to } \pm 15\text{ V}$	$V(\text{SHDN}) = 3.3\text{ V}$	370	500	μA	
t_{DIS}	Disable time (see Note 3)			200		ns	
t_{EN}	Enable time (see Note 3)			500		ns	
$I_{\text{IL}}(\text{SHDN})$	Shutdown pin low level leakage current		$V(\text{SHDN}) = 0\text{ V}$	18	25	μA	
$I_{\text{IH}}(\text{SHDN})$	Shutdown pin high level leakage current		$V(\text{SHDN}) = 3.3\text{ V}$	110	130	μA	

NOTE 3: Disable/enable time is defined as the time from when the shutdown signal is applied to the SHDN pin to when the supply current has reached half of its final value.

TYPICAL CHARACTERISTICS

Table of Graphs

			FIGURE
Small signal closed loop gain	vs Frequency		1 – 10
Small and large signal output	vs Frequency		11, 12
Harmonic distortion	vs Frequency		13, 14, 15
	vs Peak-to-peak output voltage		16, 17
V_n, I_n	Voltage noise and current noise	vs Frequency	18
CMRR	Common-mode rejection ratio	vs Frequency	19
	Crosstalk	vs Frequency	20
Z_o	Output impedance	vs Frequency	21
SR	Slew rate	vs Output voltage step	22
V_{IO}	Input offset voltage	vs Free-air temperature	23
		vs Common-mode input voltage	24
I_B	Input bias current	vs Free-air temperature	25
V_O	Output voltage	vs Load current	26
Quiescent current		vs Free-air temperature	27
		vs Supply voltage	28
I_{CC}	Shutdown supply current	vs Free-air temperature	29
	Differential gain and phase error	vs $75\ \Omega$ serially terminated loads	30, 31
	Shutdown response		32
	Small signal pulse response		33, 34
	Large signal pulse response		35, 36

TYPICAL CHARACTERISTICS

SMALL SIGNAL CLOSED LOOP GAIN
VS
FREQUENCY

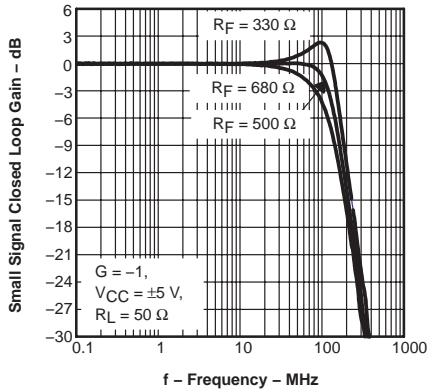

Figure 1

SMALL SIGNAL CLOSED LOOP GAIN
VS
FREQUENCY

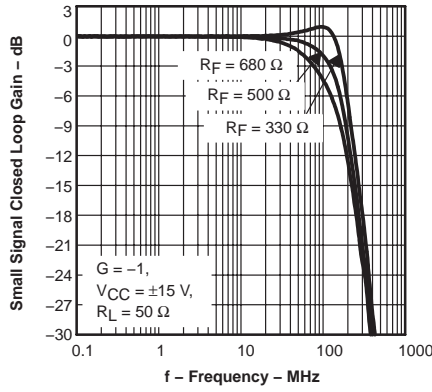

Figure 2

SMALL SIGNAL CLOSED LOOP GAIN
VS
FREQUENCY

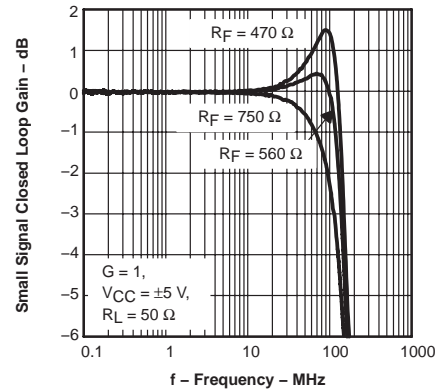

Figure 3

SMALL SIGNAL CLOSED LOOP GAIN
VS
FREQUENCY

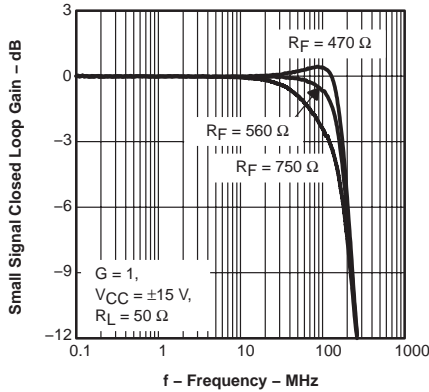

Figure 4

SMALL SIGNAL CLOSED LOOP GAIN
VS
FREQUENCY

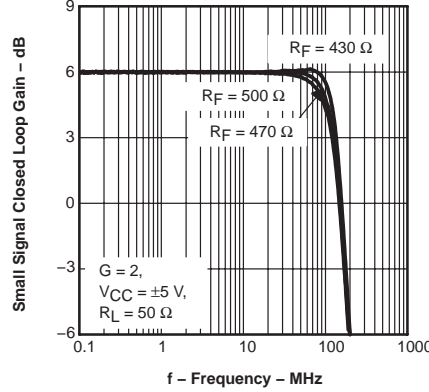

Figure 5

SMALL SIGNAL CLOSED LOOP GAIN
VS
FREQUENCY

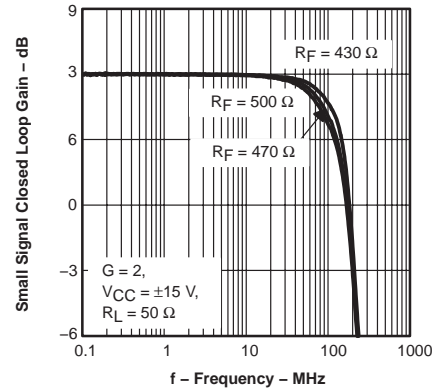

Figure 6

SMALL SIGNAL CLOSED LOOP GAIN
VS
FREQUENCY

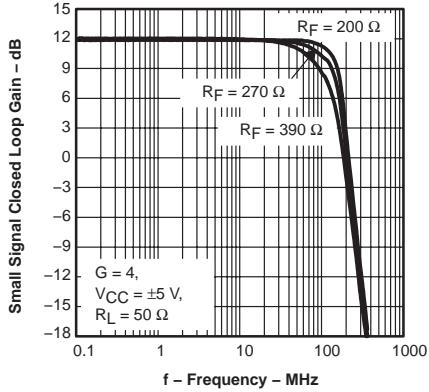

Figure 7

SMALL SIGNAL CLOSED LOOP GAIN
VS
FREQUENCY

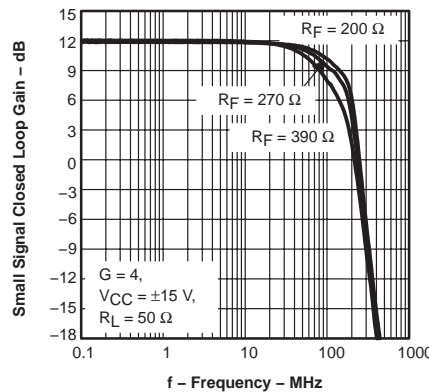

Figure 8

SMALL SIGNAL CLOSED LOOP GAIN
VS
FREQUENCY

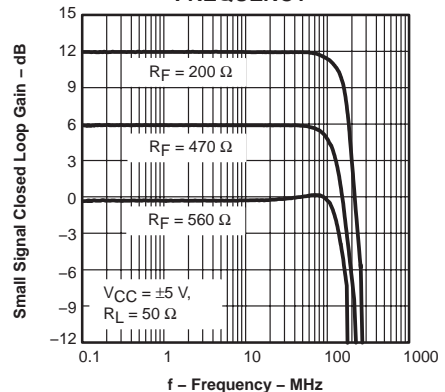

Figure 9

TYPICAL CHARACTERISTICS

SMALL SIGNAL CLOSED LOOP GAIN
VS
FREQUENCY

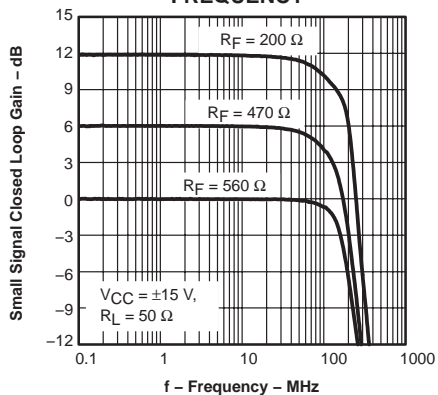

Figure 10

SMALL AND LARGE SIGNAL OUTPUT
VS
FREQUENCY

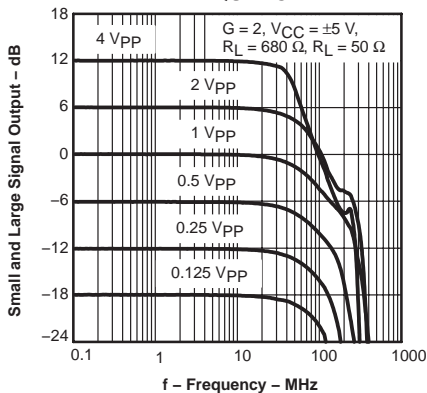

Figure 11

SMALL AND LARGE SIGNAL OUTPUT
VS
FREQUENCY

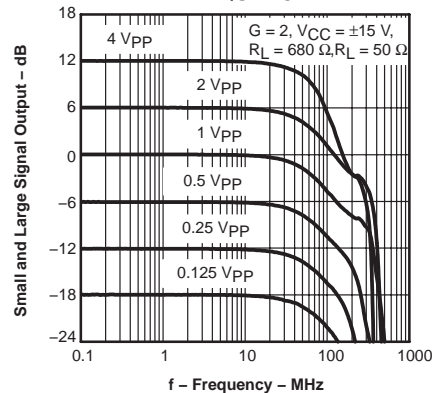

Figure 12

HARMONIC DISTORTION
VS
FREQUENCY

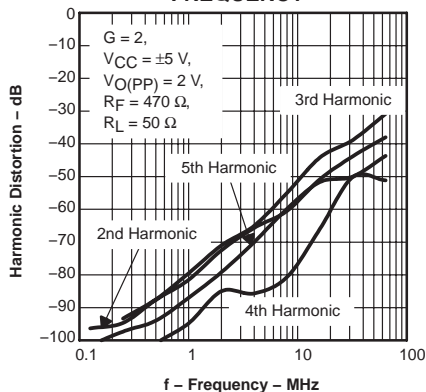

Figure 13

HARMONIC DISTORTION
VS
FREQUENCY

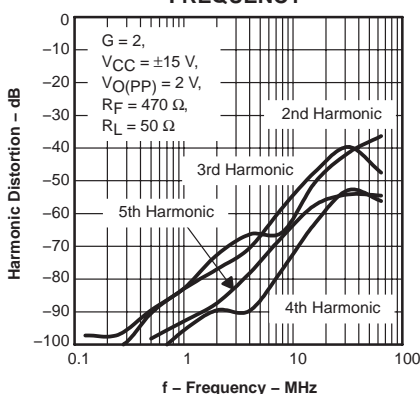

Figure 14

HARMONIC DISTORTION
VS
FREQUENCY

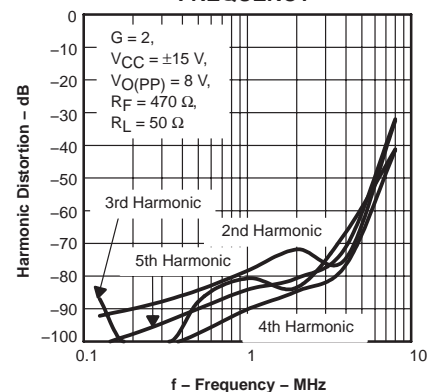

Figure 15

HARMONIC DISTORTION
VS
PEAK-TO-PEAK OUTPUT VOLTAGE

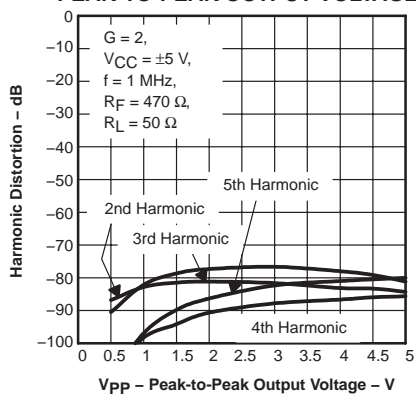

Figure 16

HARMONIC DISTORTION
VS
PEAK-TO-PEAK OUTPUT VOLTAGE

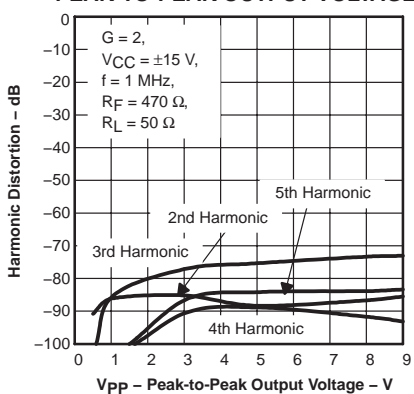

Figure 17

VOLTAGE NOISE AND CURRENT NOISE
VS
FREQUENCY

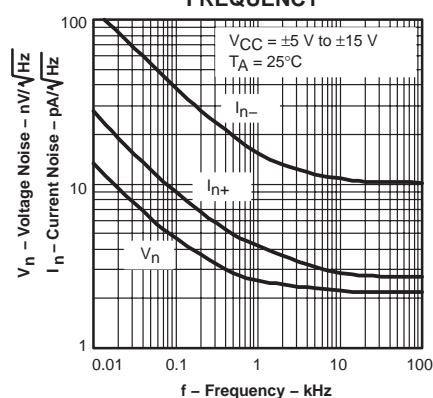

Figure 18

TYPICAL CHARACTERISTICS

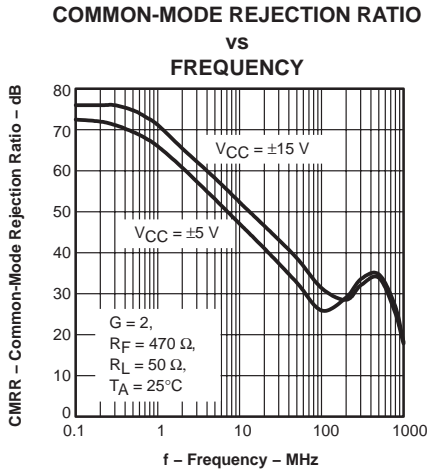

Figure 19

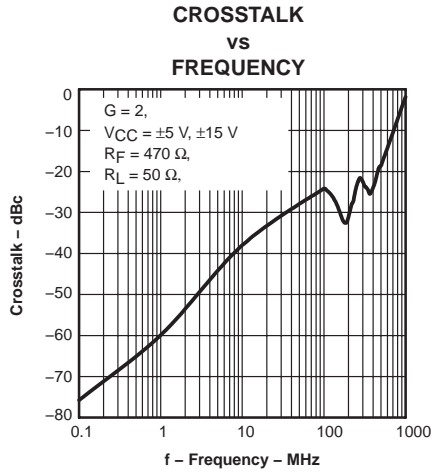

Figure 20

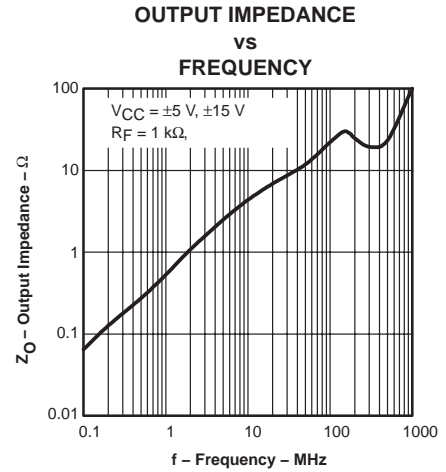

Figure 21

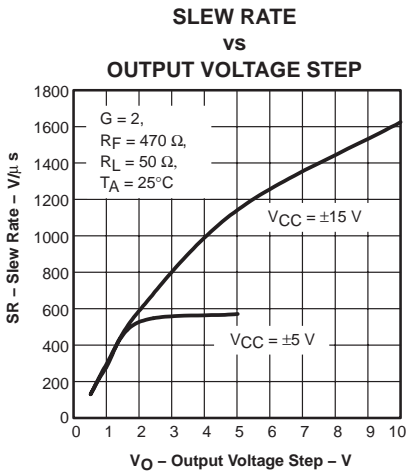

Figure 22

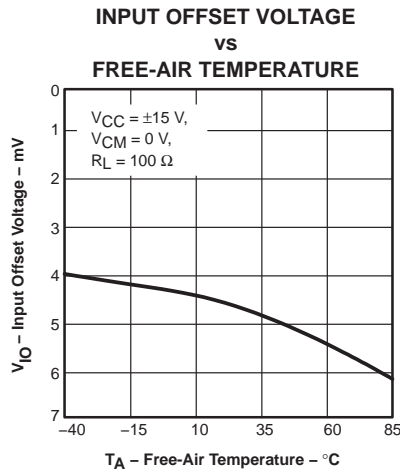

Figure 23

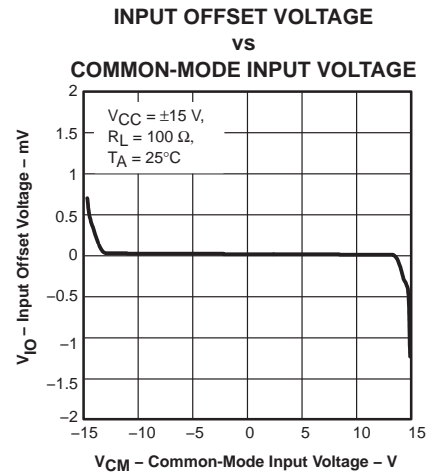

Figure 24

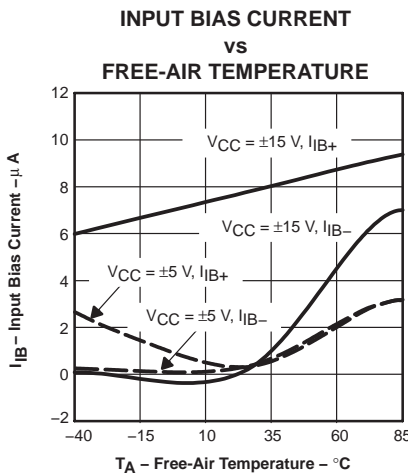

Figure 25

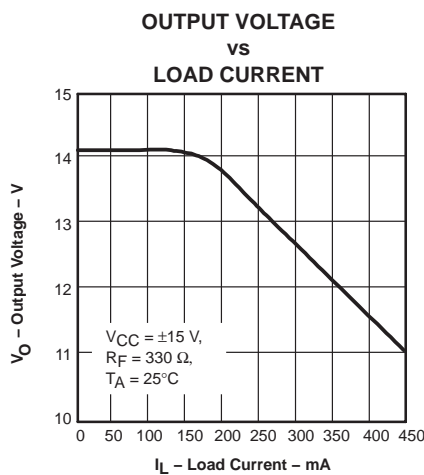

Figure 26

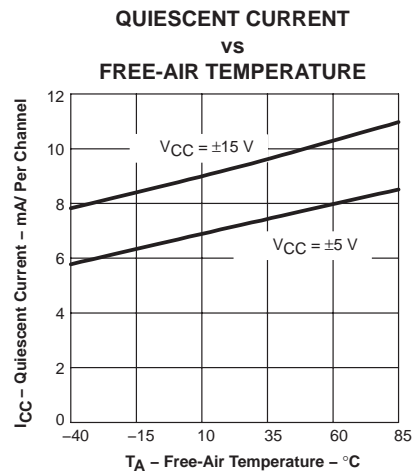

Figure 27

TYPICAL CHARACTERISTICS

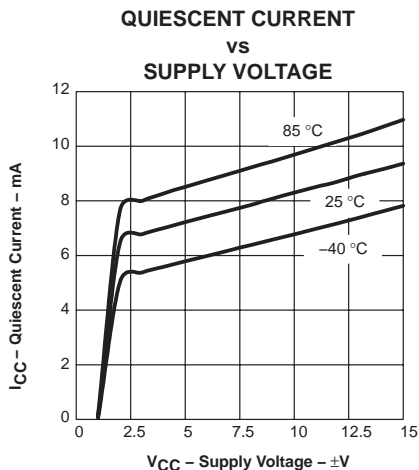

Figure 28

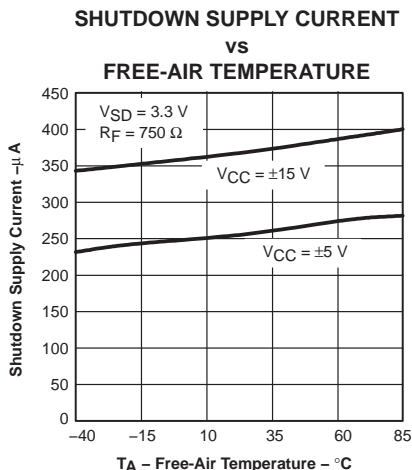

Figure 29

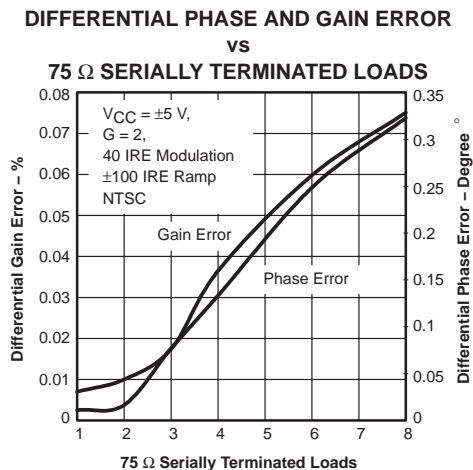

Figure 30

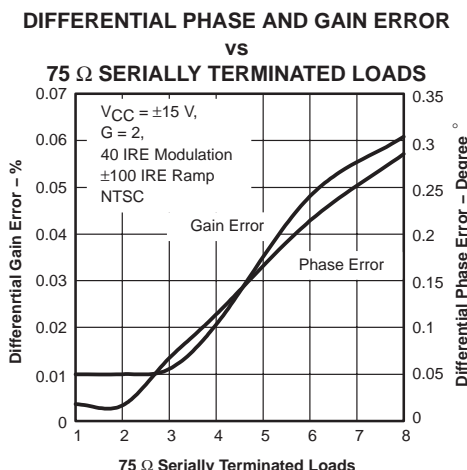

Figure 31

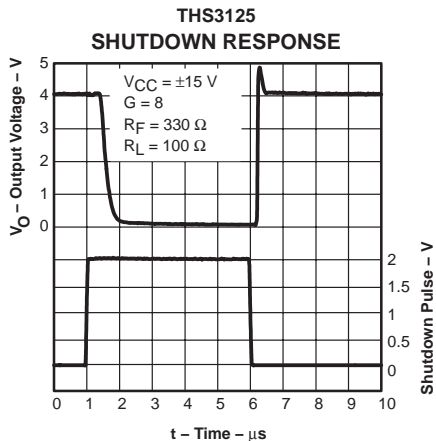

Figure 32

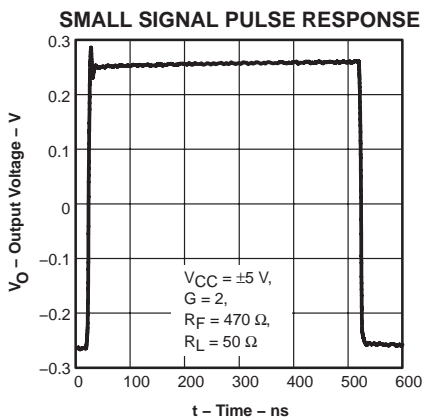

Figure 33

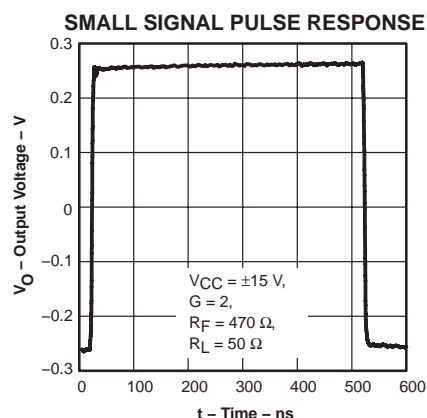

Figure 34

TYPICAL CHARACTERISTICS

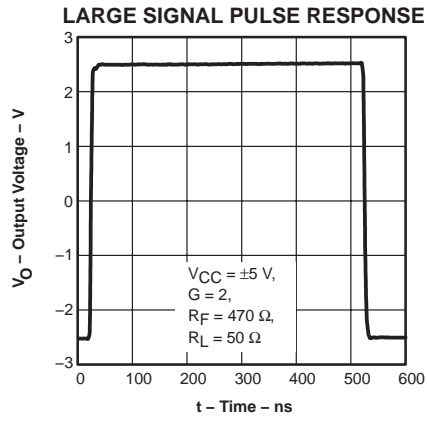

Figure 35

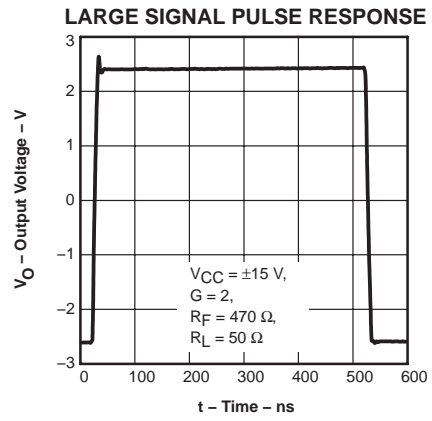

Figure 36

PACKAGING INFORMATION

Orderable Device	Status ⁽¹⁾	Package Type	Package Drawing	Pins	Package Qty	Eco Plan ⁽²⁾	Lead/Ball Finish	MSL Peak Temp ⁽³⁾
THS3122CD	ACTIVE	SOIC	D	8	75	Green (RoHS & no Sb/Br)	CU NIPDAU	Level-1-260C-UNLIM
THS3122CDDA	ACTIVE	SO Power PAD	DDA	8	75	Green (RoHS & no Sb/Br)	CU SN	Level-1-260C-UNLIM
THS3122CDDAG3	ACTIVE	SO Power PAD	DDA	8	75	Green (RoHS & no Sb/Br)	CU SN	Level-1-260C-UNLIM
THS3122CDDAR	ACTIVE	SO Power PAD	DDA	8	2500	Green (RoHS & no Sb/Br)	CU SN	Level-1-260C-UNLIM
THS3122CDDARG3	ACTIVE	SO Power PAD	DDA	8	2500	Green (RoHS & no Sb/Br)	CU SN	Level-1-260C-UNLIM
THS3122CDG4	ACTIVE	SOIC	D	8	75	Green (RoHS & no Sb/Br)	CU NIPDAU	Level-1-260C-UNLIM
THS3122CDR	ACTIVE	SOIC	D	8	2500	Green (RoHS & no Sb/Br)	CU NIPDAU	Level-1-260C-UNLIM
THS3122CDRG4	ACTIVE	SOIC	D	8	2500	Green (RoHS & no Sb/Br)	CU NIPDAU	Level-1-260C-UNLIM
THS3122ID	ACTIVE	SOIC	D	8	75	Green (RoHS & no Sb/Br)	CU NIPDAU	Level-1-260C-UNLIM
THS3122IDDA	ACTIVE	SO Power PAD	DDA	8	75	Green (RoHS & no Sb/Br)	CU SN	Level-1-260C-UNLIM
THS3122IDDAG3	ACTIVE	SO Power PAD	DDA	8	75	Green (RoHS & no Sb/Br)	CU SN	Level-1-260C-UNLIM
THS3122IDDAR	ACTIVE	SO Power PAD	DDA	8	2500	Green (RoHS & no Sb/Br)	CU SN	Level-1-260C-UNLIM
THS3122IDDARG3	ACTIVE	SO Power PAD	DDA	8	2500	Green (RoHS & no Sb/Br)	CU SN	Level-1-260C-UNLIM
THS3122IDG4	ACTIVE	SOIC	D	8	75	Green (RoHS & no Sb/Br)	CU NIPDAU	Level-1-260C-UNLIM
THS3125CPWP	ACTIVE	HTSSOP	PWP	14	90	Green (RoHS & no Sb/Br)	CU NIPDAU	Level-2-260C-1 YEAR
THS3125CPWPG4	ACTIVE	HTSSOP	PWP	14	90	Green (RoHS & no Sb/Br)	CU NIPDAU	Level-2-260C-1 YEAR
THS3125ID	ACTIVE	SOIC	D	14	50	Green (RoHS & no Sb/Br)	CU NIPDAU	Level-1-260C-UNLIM
THS3125IDG4	ACTIVE	SOIC	D	14	50	Green (RoHS & no Sb/Br)	CU NIPDAU	Level-1-260C-UNLIM
THS3125IPWP	ACTIVE	HTSSOP	PWP	14	90	Green (RoHS & no Sb/Br)	CU NIPDAU	Level-2-260C-1 YEAR
THS3125IPWPG4	ACTIVE	HTSSOP	PWP	14	90	Green (RoHS & no Sb/Br)	CU NIPDAU	Level-2-260C-1 YEAR
THS3125IPWPR	ACTIVE	HTSSOP	PWP	14	2000	Green (RoHS & no Sb/Br)	CU NIPDAU	Level-2-260C-1 YEAR
THS3125IPWPRG4	ACTIVE	HTSSOP	PWP	14	2000	Green (RoHS & no Sb/Br)	CU NIPDAU	Level-2-260C-1 YEAR

Orderable Device	Status ⁽¹⁾	Package Type	Package Drawing	Pins	Package Qty	Eco Plan ⁽²⁾	Lead/Ball Finish	MSL Peak Temp ⁽³⁾
no Sb/Br)								

⁽¹⁾ The marketing status values are defined as follows:

ACTIVE: Product device recommended for new designs.

LIFEBUY: TI has announced that the device will be discontinued, and a lifetime-buy period is in effect.

NRND: Not recommended for new designs. Device is in production to support existing customers, but TI does not recommend using this part in a new design.

PREVIEW: Device has been announced but is not in production. Samples may or may not be available.

OBSOLETE: TI has discontinued the production of the device.

⁽²⁾ Eco Plan - The planned eco-friendly classification: Pb-Free (RoHS), Pb-Free (RoHS Exempt), or Green (RoHS & no Sb/Br) - please check <http://www.ti.com/productcontent> for the latest availability information and additional product content details.

TBD: The Pb-Free/Green conversion plan has not been defined.

Pb-Free (RoHS): TI's terms "Lead-Free" or "Pb-Free" mean semiconductor products that are compatible with the current RoHS requirements for all 6 substances, including the requirement that lead not exceed 0.1% by weight in homogeneous materials. Where designed to be soldered at high temperatures, TI Pb-Free products are suitable for use in specified lead-free processes.

Pb-Free (RoHS Exempt): This component has a RoHS exemption for either 1) lead-based flip-chip solder bumps used between the die and package, or 2) lead-based die adhesive used between the die and leadframe. The component is otherwise considered Pb-Free (RoHS compatible) as defined above.

Green (RoHS & no Sb/Br): TI defines "Green" to mean Pb-Free (RoHS compatible), and free of Bromine (Br) and Antimony (Sb) based flame retardants (Br or Sb do not exceed 0.1% by weight in homogeneous material)

⁽³⁾ MSL, Peak Temp. -- The Moisture Sensitivity Level rating according to the JEDEC industry standard classifications, and peak solder temperature.

Important Information and Disclaimer:The information provided on this page represents TI's knowledge and belief as of the date that it is provided. TI bases its knowledge and belief on information provided by third parties, and makes no representation or warranty as to the accuracy of such information. Efforts are underway to better integrate information from third parties. TI has taken and continues to take reasonable steps to provide representative and accurate information but may not have conducted destructive testing or chemical analysis on incoming materials and chemicals. TI and TI suppliers consider certain information to be proprietary, and thus CAS numbers and other limited information may not be available for release.

In no event shall TI's liability arising out of such information exceed the total purchase price of the TI part(s) at issue in this document sold by TI to Customer on an annual basis.

TAPE AND REEL INFORMATION



QUADRANT ASSIGNMENTS FOR PIN 1 ORIENTATION IN TAPE



*All dimensions are nominal

Device	Package Type	Package Drawing	Pins	SPQ	Reel Diameter (mm)	Reel Width W1 (mm)	A0 (mm)	B0 (mm)	K0 (mm)	P1 (mm)	W (mm)	Pin1 Quadrant
THS3122CDDAR	SO Power PAD	DDA	8	2500	330.0	12.4	6.4	5.2	2.1	8.0	12.0	Q1
THS3122CDR	SOIC	D	8	2500	330.0	12.4	6.4	5.2	2.1	8.0	12.0	Q1
THS3122IDDAR	SO Power PAD	DDA	8	2500	330.0	12.4	6.4	5.2	2.1	8.0	12.0	Q1
THS3125IPWPR	HTSSOP	PWP	14	2000	330.0	12.4	6.67	5.4	1.6	8.0	12.0	Q1

TAPE AND REEL BOX DIMENSIONS



*All dimensions are nominal

Device	Package Type	Package Drawing	Pins	SPQ	Length (mm)	Width (mm)	Height (mm)
THS3122CDDAR	SO PowerPAD	DDA	8	2500	346.0	346.0	29.0
THS3122CDR	SOIC	D	8	2500	346.0	346.0	29.0
THS3122IDDAR	SO PowerPAD	DDA	8	2500	346.0	346.0	29.0
THS3125IPWPR	HTSSOP	PWP	14	2000	346.0	346.0	29.0

D (R-PDSO-G8)

PLASTIC SMALL-OUTLINE PACKAGE

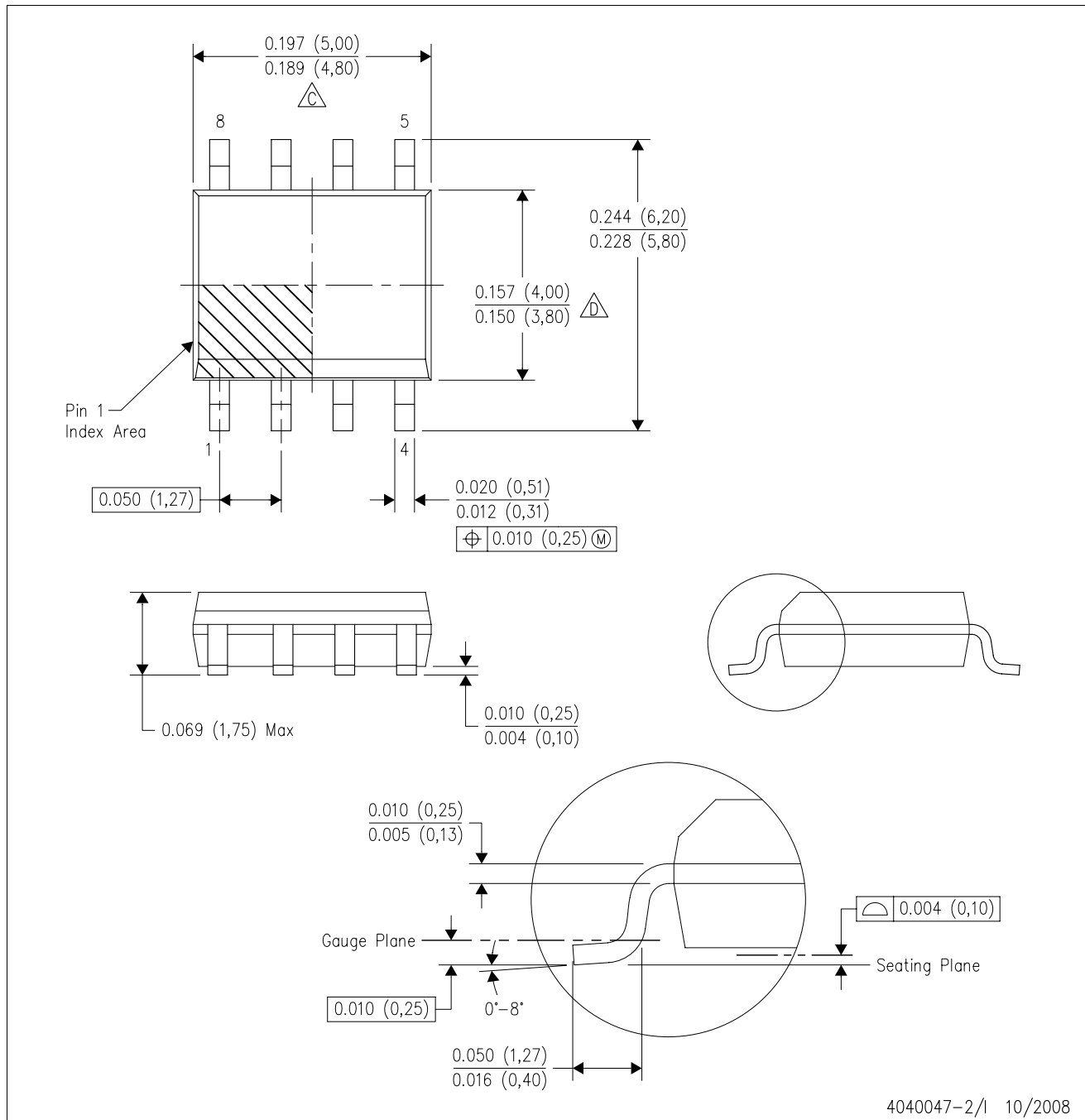

- NOTES:
- A. All linear dimensions are in inches (millimeters).
 - B. This drawing is subject to change without notice.
 - C. Body length does not include mold flash, protrusions, or gate burrs. Mold flash, protrusions, or gate burrs shall not exceed .006 (0,15) per end.
 - D. Body width does not include interlead flash. Interlead flash shall not exceed .017 (0,43) per side.
 - E. Reference JEDEC MS-012 variation AA.

D (R-PDSO-G14)

PLASTIC SMALL-OUTLINE PACKAGE

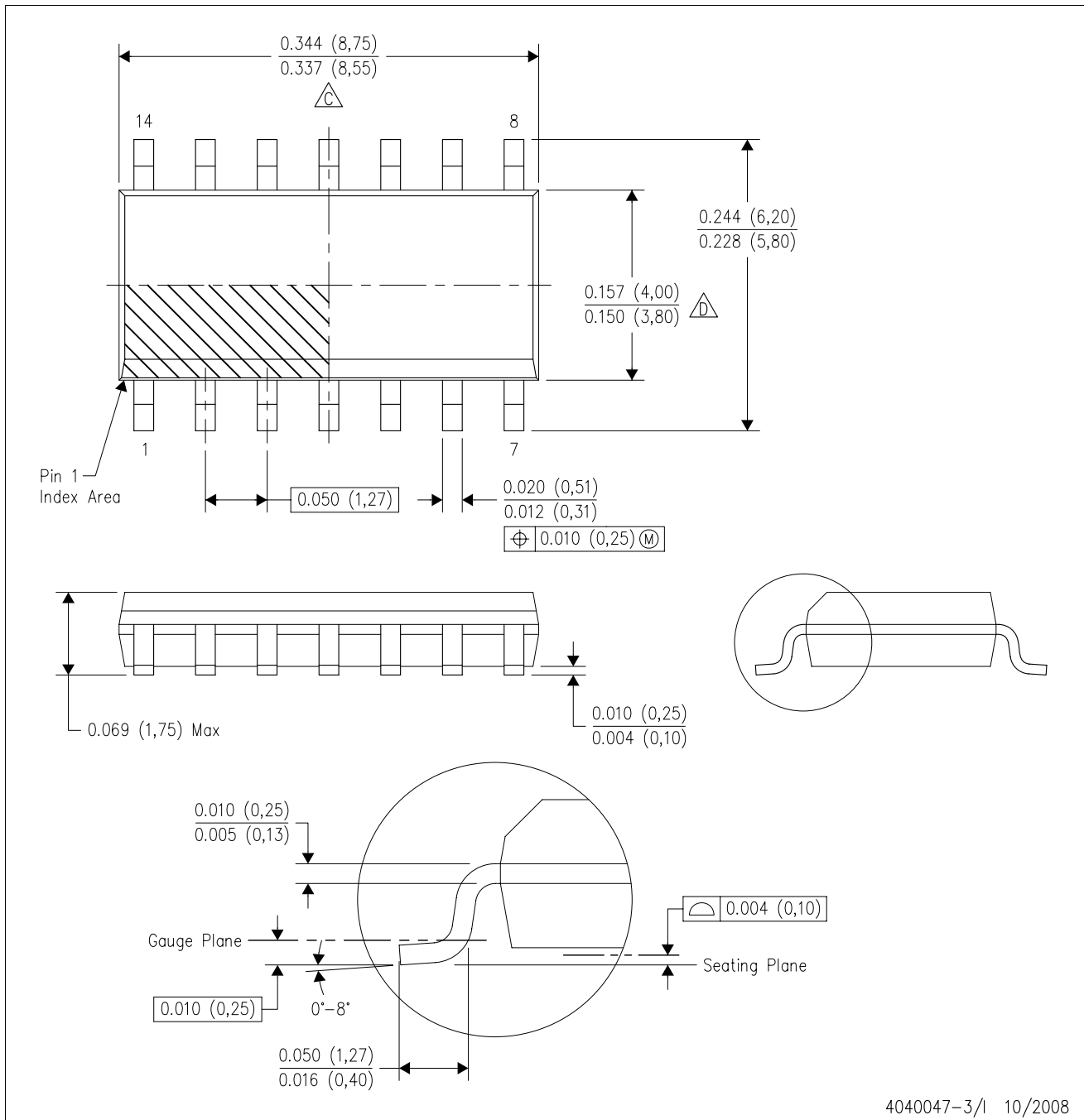

- NOTES:
- A. All linear dimensions are in inches (millimeters).
 - B. This drawing is subject to change without notice.
 - $\triangle C$ Body length does not include mold flash, protrusions, or gate burrs. Mold flash, protrusions, or gate burrs shall not exceed .006 (0,15) per end.
 - $\triangle D$ Body width does not include interlead flash. Interlead flash shall not exceed .017 (0,43) per side.
 - E. Reference JEDEC MS-012 variation AB.

DDA (R-PDSO-G8)

PowerPAD™ PLASTIC SMALL-OUTLINE PACKAGE

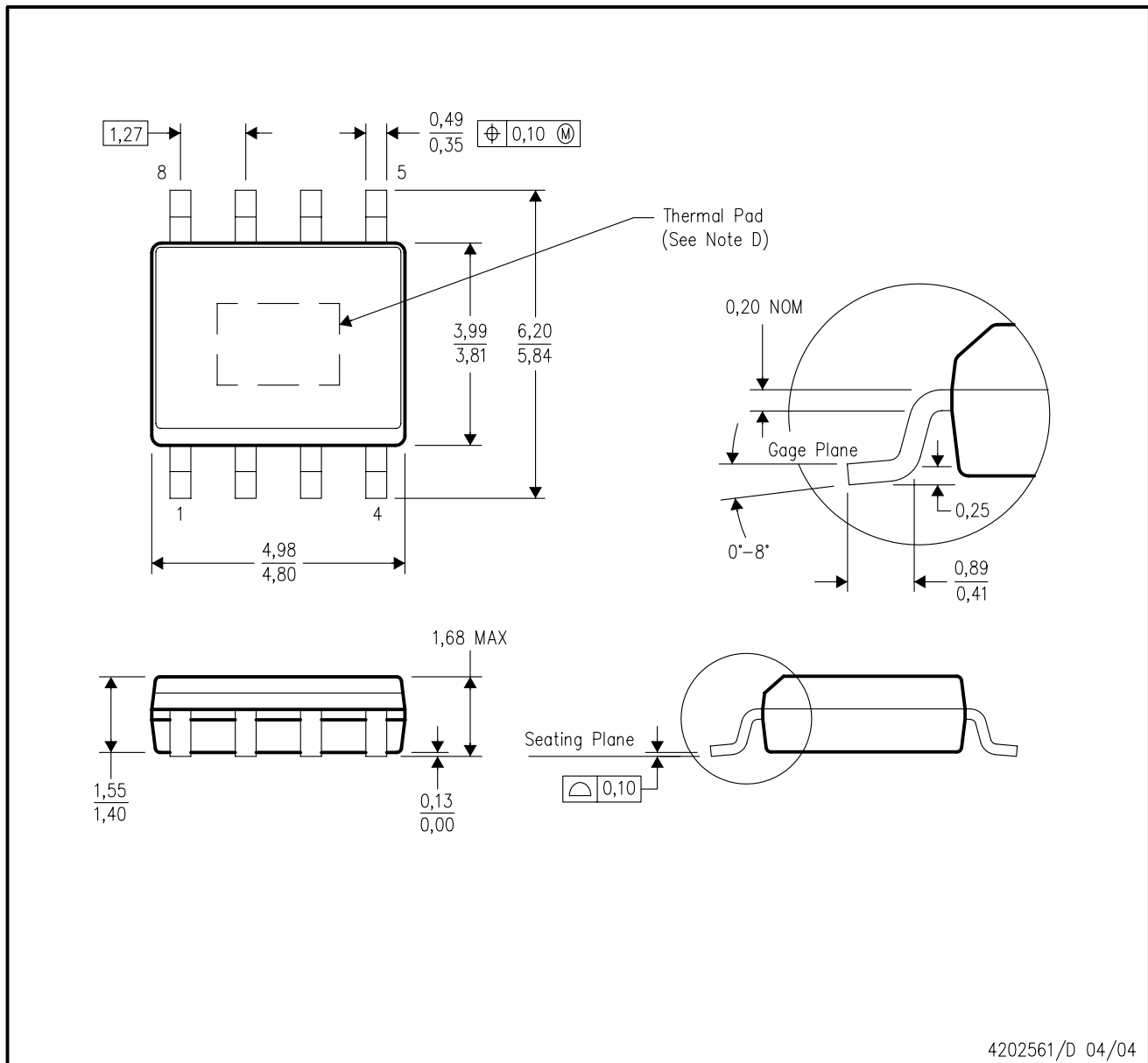

- NOTES:
- All linear dimensions are in millimeters.
 - This drawing is subject to change without notice.
 - Body dimensions do not include mold flash or protrusion not to exceed 0,15.
 - This package is designed to be soldered to a thermal pad on the board. Refer to Technical Brief, PowerPad Thermally Enhanced Package, Texas Instruments Literature No. SLMA002 for information regarding recommended board layout. This document is available at www.ti.com <<http://www.ti.com>>.

PowerPAD is a trademark of Texas Instruments.

THERMAL INFORMATION

This PowerPAD™ package incorporates an exposed thermal pad that is designed to be attached directly to an external heatsink. The thermal pad must be soldered directly to the printed circuit board (PCB). After soldering, the PCB can be used as a heatsink. In addition, through the use of thermal vias, the thermal pad can be attached directly to the appropriate copper plane shown in the electrical schematic for the device, or alternatively, can be attached to a special heatsink structure designed into the PCB. This design optimizes the heat transfer from the integrated circuit (IC).

For additional information on the PowerPAD package and how to take advantage of its heat dissipating abilities, refer to Technical Brief, PowerPAD Thermally Enhanced Package, Texas Instruments Literature No. SLMA002 and Application Brief, PowerPAD Made Easy, Texas Instruments Literature No. SLMA004. Both documents are available at www.ti.com.

The exposed thermal pad dimensions for this package are shown in the following illustration.

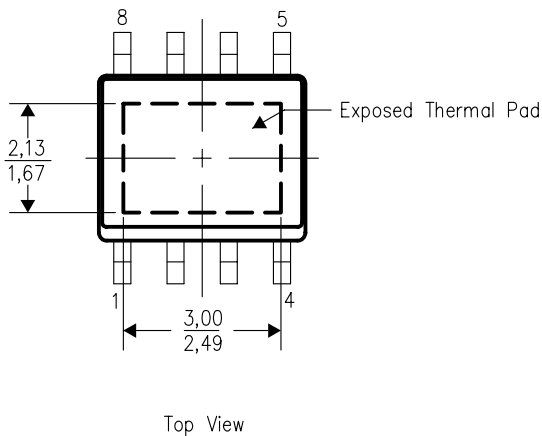

NOTE: All linear dimensions are in millimeters

Exposed Thermal Pad Dimensions

DDA (R-PDSO-G8) PowerPAD™

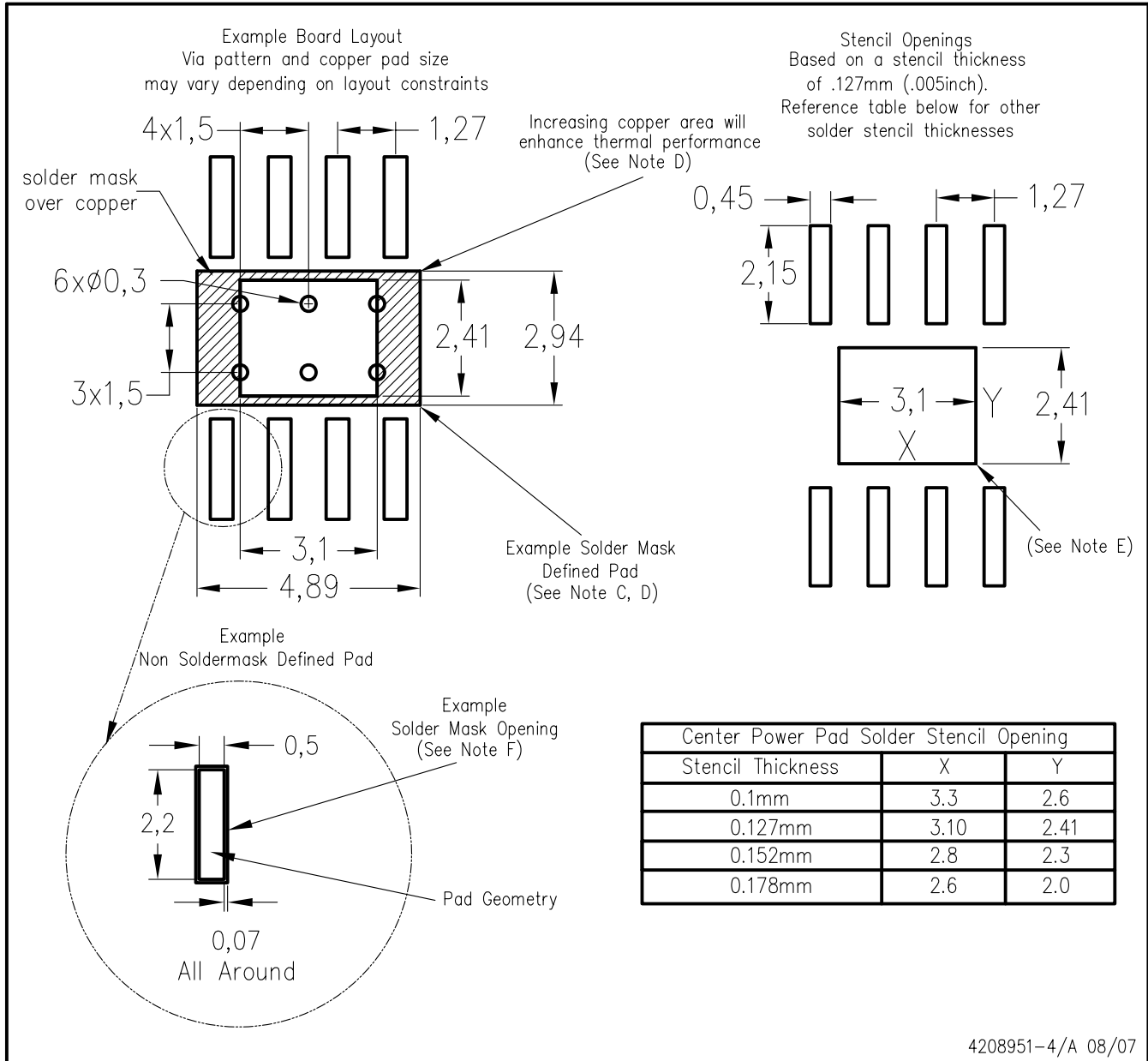

- NOTES:
- A. All linear dimensions are in millimeters.
 - B. This drawing is subject to change without notice.
 - C. Customers should place a note on the circuit board fabrication drawing not to alter the center solder mask defined pad.
 - D. This package is designed to be soldered to a thermal pad on the board. Refer to Technical Brief, PowerPAD Thermally Enhanced Package, Texas Instruments Literature No. SLMA002, SLMA004, and also the Product Data Sheets for specific thermal information, via requirements, and recommended board layout. These documents are available at www.ti.com <<http://www.ti.com>>. Publication IPC-7351 is recommended for alternate designs.
 - E. Laser cutting apertures with trapezoidal walls and also rounding corners will offer better paste release. Customers should contact their board assembly site for stencil design recommendations. Example stencil design based on a 50% volumetric metal load solder paste. Refer to IPC-7525 for other stencil recommendations.
 - F. Customers should contact their board fabrication site for solder mask tolerances between and around signal pads.

PowerPAD is a trademark of Texas Instruments.

PWP (R-PDSO-G**)

PowerPAD™ PLASTIC SMALL-OUTLINE PACKAGE

20 PIN SHOWN

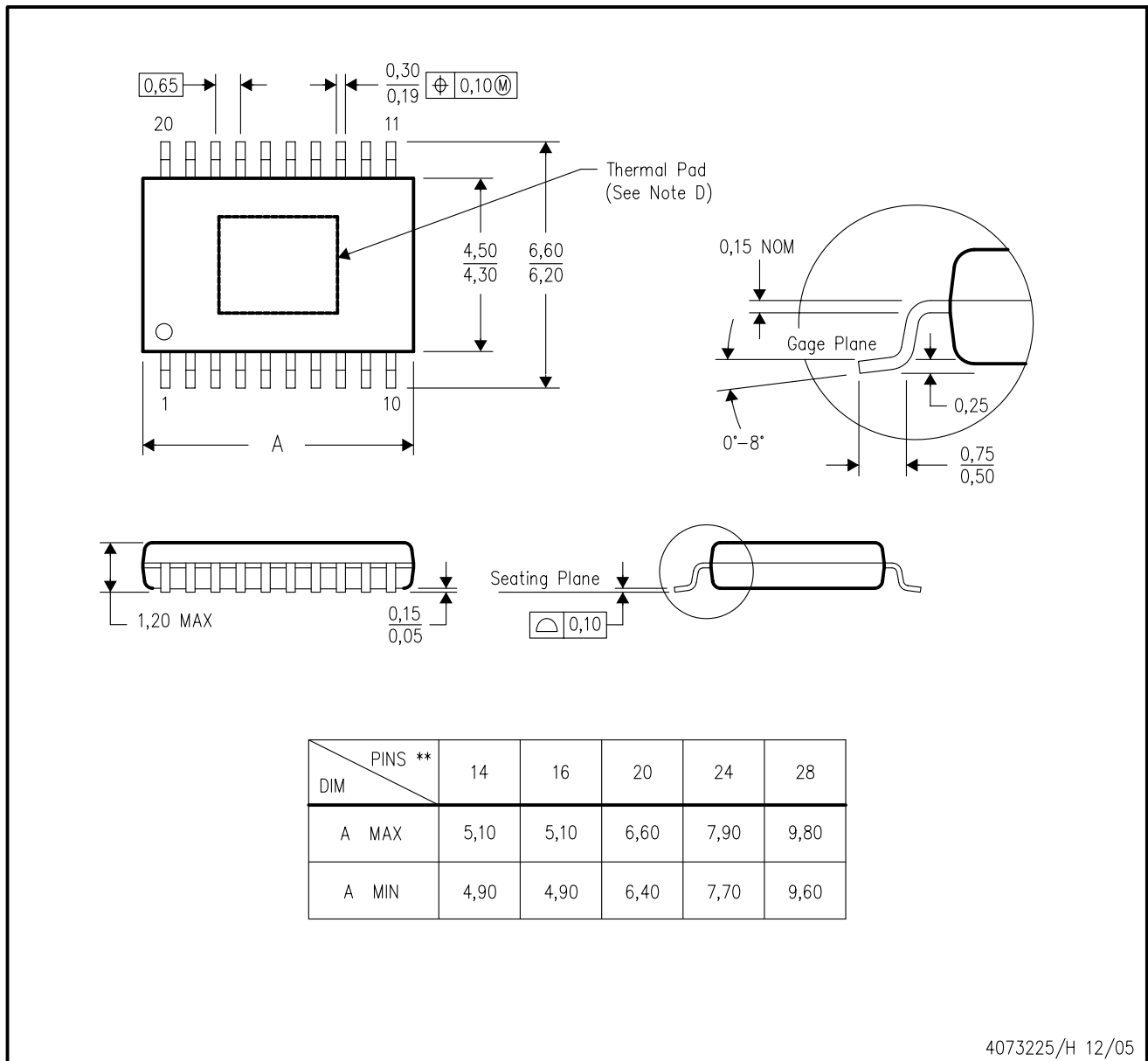

4073225/H 12/05

- NOTES:
- A. All linear dimensions are in millimeters.
 - B. This drawing is subject to change without notice.
 - C. Body dimensions do not include mold flash or protrusions. Mold flash and protrusion shall not exceed 0.15 per side.
 - D. This package is designed to be soldered to a thermal pad on the board. Refer to Technical Brief, PowerPad Thermally Enhanced Package, Texas Instruments Literature No. SLMA002 for information regarding recommended board layout. This document is available at www.ti.com <<http://www.ti.com>>.
 - E. Falls within JEDEC MO-153

PowerPAD is a trademark of Texas Instruments.

THERMAL INFORMATION

This PowerPAD™ package incorporates an exposed thermal pad that is designed to be attached to a printed circuit board (PCB). The thermal pad must be soldered directly to the PCB. After soldering, the PCB can be used as a heatsink. In addition, through the use of thermal vias, the thermal pad can be attached directly to the appropriate copper plane shown in the electrical schematic for the device, or alternatively, can be attached to a special heatsink structure designed into the PCB. This design optimizes the heat transfer from the integrated circuit (IC).

For additional information on the PowerPAD package and how to take advantage of its heat dissipating abilities, refer to Technical Brief, PowerPAD Thermally Enhanced Package, Texas Instruments Literature No. SLMA002 and Application Brief, PowerPAD Made Easy, Texas Instruments Literature No. SLMA004. Both documents are available at www.ti.com.

The exposed thermal pad dimensions for this package are shown in the following illustration.

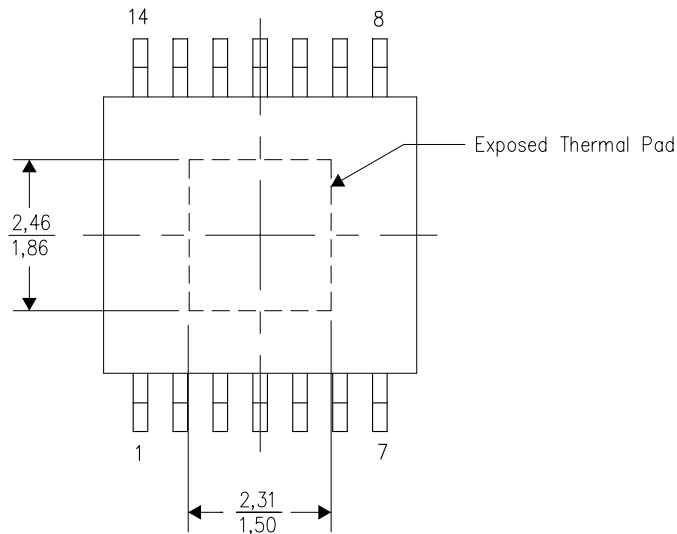

Top View

NOTE: All linear dimensions are in millimeters

Exposed Thermal Pad Dimensions

PWP (R-PDSO-G14) PowerPAD™

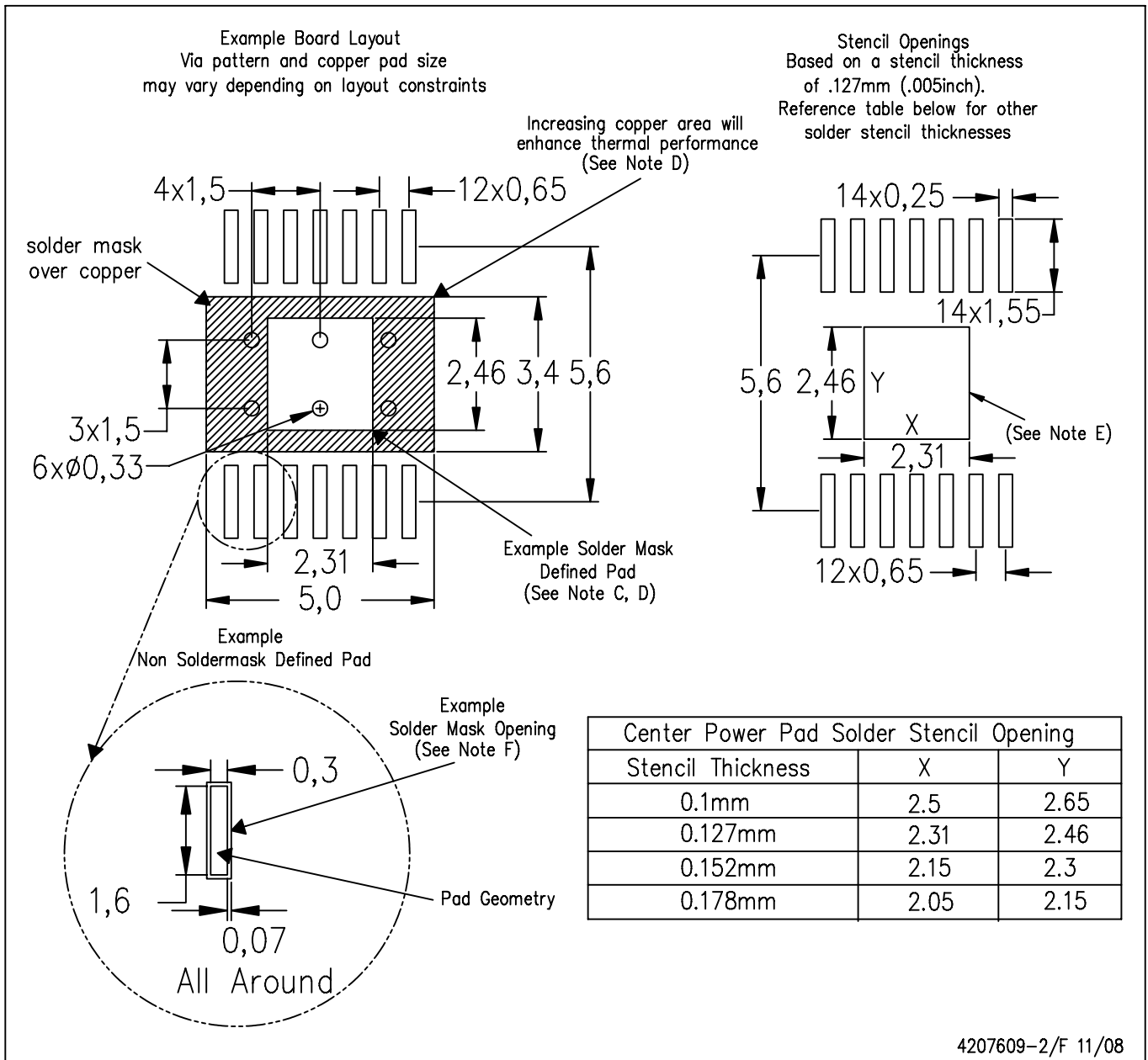

4207609-2/F 11/08

- NOTES:
- All linear dimensions are in millimeters.
 - This drawing is subject to change without notice.
 - Customers should place a note on the circuit board fabrication drawing not to alter the center solder mask defined pad.
 - This package is designed to be soldered to a thermal pad on the board. Refer to Technical Brief, PowerPad Thermally Enhanced Package, Texas Instruments Literature No. SLMA002, SLMA004, and also the Product Data Sheets for specific thermal information, via requirements, and recommended board layout. These documents are available at www.ti.com <<http://www.ti.com>>. Publication IPC-7351 is recommended for alternate designs.
 - Laser cutting apertures with trapezoidal walls and also rounding corners will offer better paste release. Customers should contact their board assembly site for stencil design recommendations. Example stencil design based on a 50% volumetric metal load solder paste. Refer to IPC-7525 for other stencil recommendations.
 - Customers should contact their board fabrication site for solder mask tolerances between and around signal pads.

PowerPAD is a trademark of Texas Instruments.

IMPORTANT NOTICE

Texas Instruments Incorporated and its subsidiaries (TI) reserve the right to make corrections, modifications, enhancements, improvements, and other changes to its products and services at any time and to discontinue any product or service without notice. Customers should obtain the latest relevant information before placing orders and should verify that such information is current and complete. All products are sold subject to TI's terms and conditions of sale supplied at the time of order acknowledgment.

TI warrants performance of its hardware products to the specifications applicable at the time of sale in accordance with TI's standard warranty. Testing and other quality control techniques are used to the extent TI deems necessary to support this warranty. Except where mandated by government requirements, testing of all parameters of each product is not necessarily performed.

TI assumes no liability for applications assistance or customer product design. Customers are responsible for their products and applications using TI components. To minimize the risks associated with customer products and applications, customers should provide adequate design and operating safeguards.

TI does not warrant or represent that any license, either express or implied, is granted under any TI patent right, copyright, mask work right, or other TI intellectual property right relating to any combination, machine, or process in which TI products or services are used. Information published by TI regarding third-party products or services does not constitute a license from TI to use such products or services or a warranty or endorsement thereof. Use of such information may require a license from a third party under the patents or other intellectual property of the third party, or a license from TI under the patents or other intellectual property of TI.

Reproduction of TI information in TI data books or data sheets is permissible only if reproduction is without alteration and is accompanied by all associated warranties, conditions, limitations, and notices. Reproduction of this information with alteration is an unfair and deceptive business practice. TI is not responsible or liable for such altered documentation. Information of third parties may be subject to additional restrictions.

Resale of TI products or services with statements different from or beyond the parameters stated by TI for that product or service voids all express and any implied warranties for the associated TI product or service and is an unfair and deceptive business practice. TI is not responsible or liable for any such statements.

TI products are not authorized for use in safety-critical applications (such as life support) where a failure of the TI product would reasonably be expected to cause severe personal injury or death, unless officers of the parties have executed an agreement specifically governing such use. Buyers represent that they have all necessary expertise in the safety and regulatory ramifications of their applications, and acknowledge and agree that they are solely responsible for all legal, regulatory and safety-related requirements concerning their products and any use of TI products in such safety-critical applications, notwithstanding any applications-related information or support that may be provided by TI. Further, Buyers must fully indemnify TI and its representatives against any damages arising out of the use of TI products in such safety-critical applications.

TI products are neither designed nor intended for use in military/aerospace applications or environments unless the TI products are specifically designated by TI as military-grade or "enhanced plastic." Only products designated by TI as military-grade meet military specifications. Buyers acknowledge and agree that any such use of TI products which TI has not designated as military-grade is solely at the Buyer's risk, and that they are solely responsible for compliance with all legal and regulatory requirements in connection with such use.

TI products are neither designed nor intended for use in automotive applications or environments unless the specific TI products are designated by TI as compliant with ISO/TS 16949 requirements. Buyers acknowledge and agree that, if they use any non-designated products in automotive applications, TI will not be responsible for any failure to meet such requirements.

Following are URLs where you can obtain information on other Texas Instruments products and application solutions:

Products

Amplifiers	amplifier.ti.com
Data Converters	dataconverter.ti.com
DSP	dsp.ti.com
Clocks and Timers	www.ti.com/clocks
Interface	interface.ti.com
Logic	logic.ti.com
Power Mgmt	power.ti.com
Microcontrollers	microcontroller.ti.com
RFID	www.ti-rfid.com
RF/IF and ZigBee® Solutions	www.ti.com/lprf

Applications

Audio	www.ti.com/audio
Automotive	www.ti.com/automotive
Broadband	www.ti.com/broadband
Digital Control	www.ti.com/digitalcontrol
Medical	www.ti.com/medical
Military	www.ti.com/military
Optical Networking	www.ti.com/opticalnetwork
Security	www.ti.com/security
Telephony	www.ti.com/telephony
Video & Imaging	www.ti.com/video
Wireless	www.ti.com/wireless

Mailing Address: Texas Instruments, Post Office Box 655303, Dallas, Texas 75265
Copyright © 2008, Texas Instruments Incorporated